

Roger™ Touchscreen Mic

Quick setup guide | Schnellstartanleitung

Guide d'installation rapide | Guía rápida de instalación



röger



PHONAK
life is on

Device description
 Produktbeschreibung
 Description de l'appareil
 Descripción del dispositivo

- ① On/Off
- ② Wake/sleep
 Ein/Aus Standby
 Marche/veille
 Activación/reposo

- ③ Indicator light
 Statusanzeige
 Témoin lumineux
 Indicador luminoso

- ④ Microphones
 Mikrofonen
 Microphones
 Micrófonos

- ⑤ Mute
 Stumm
 Mode sourdine
 Modo silencio

- ⑥ Touchscreen display
 Touchscreen Bildschirm
 Ecran Touchscreen
 Pantalla Touchscreen

- ⑦ micro-USB

- ⑧ Jack 3.5 mm / 1/8"

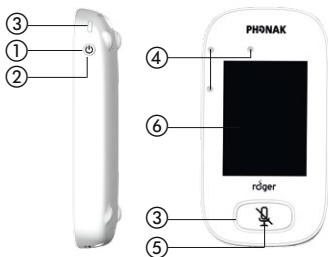

Device description
Produktbeschreibung
Description de l'appareil
Descripción del dispositivo

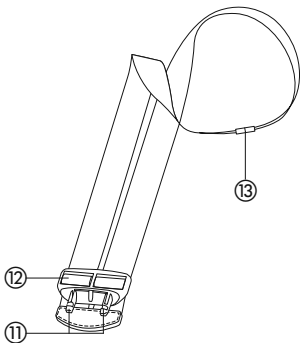
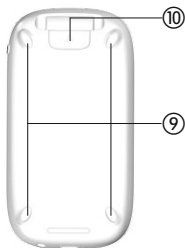

- ⑨ Feet
Füße
Pieds
Pies
- ⑩ **Lanyard:**
Clip/remove button
Ein-/Aus-Taste
Bouton mettre/enlever
Botón encender/apagar
- ⑪ Lanyard clip
- ⑫ Length adjustment
Länge einstellen
Ajustement longueur
Ajustar longitud
- ⑬ Safety breakaway
Sicherheitsverschluss
Bouton de sécurité
Botón de seguridad

Components
 Komponenten
 Composants
 Componentes



Roger Touchscreen Mic

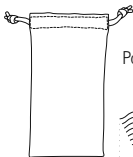

Pouch | Beutel | Poche | Bolso

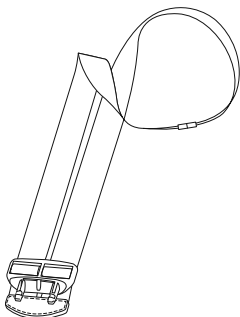

Lanyard

Package contents may vary slightly depending on country.
 Der Lieferumfang kann je nach Land variieren.
 Le contenu peut varier selon les pays.
 El contenido puede variar dependiendo del país.

Charging
Aufladen
Charger
Cargar

A

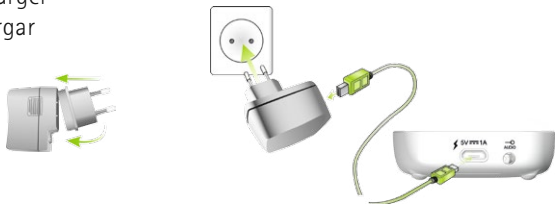

B



C

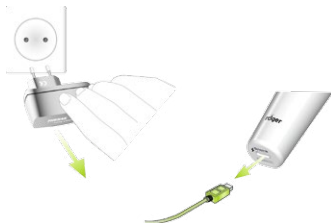

Switching On/Off
Ein-/Ausschalten
Mise en marche/éteindre
Encender/apagar



Mute
Stumm
Sourdine
Silenciar



Touchscreen display
Touchscreen Bildschirm
Ecran Touchscreen
Pantalla Touchscreen



Connecting
Verbinden
Connecter
Conectar

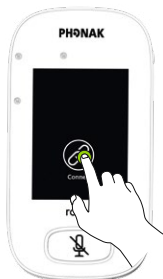

Distance
Distanz 0-10 cm
Distance 0-4 inches
Distancia

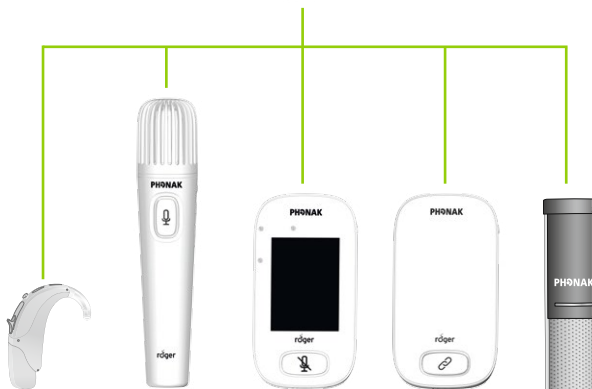

Sleep
Stand-by
Veille
Reposo

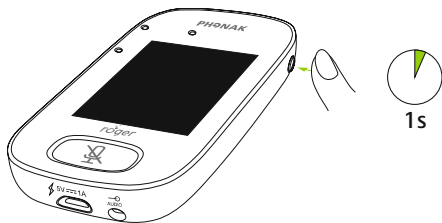

Wake
Ein
Marche
Activación

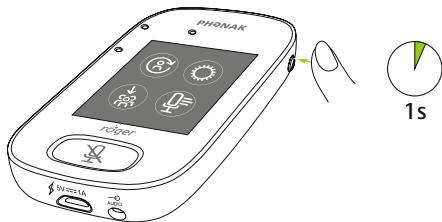

Microphone usage
 Als Mikrofon verwenden
 Utilisation comme microphone
 Utilizar como micrófono



Microphone mode	
Automatic	✓
Small Group	
Pointing	
Lanyard	



Small Group

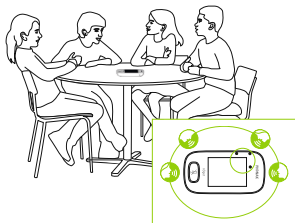

Pointing

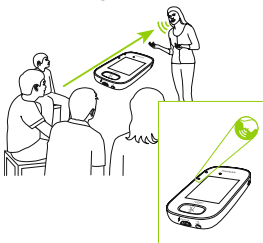

Lanyard

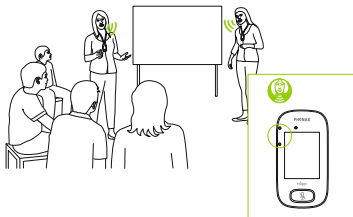

Lanyard: How to use

Lanyard: Wie benützen

Lanyard: Comment utiliser

Lanyard: Como utilizar

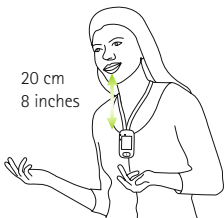
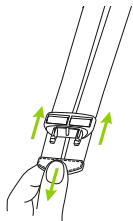
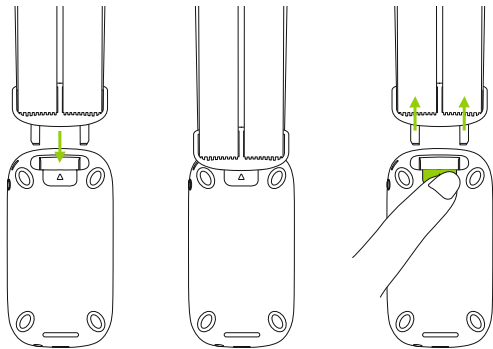

Recording: How to use
Aufnahme: Wie benützen
Enregistrement: Comment utiliser
Grabación: Como utilizar

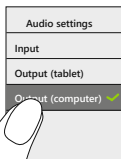
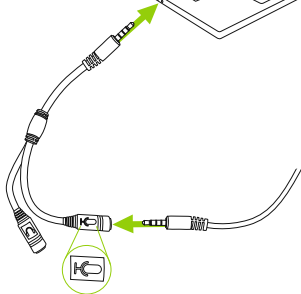
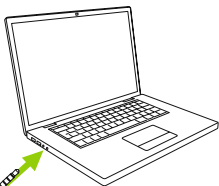



Indicator light
Statusanzeige
Témoins lumineux
Indicador luminoso



On/Off



Charging | Aufladen | Charge | Cargar



Fully charged | Voll aufgeladen |
complètement chargé | Completamente cargado



Mute | Stumm | Mode sourdine | Modo silencio



Primary not available | Primary nicht verfügbar |
Primary indisponible | Primario no disponible



On/Off



Charging | Aufladen | Charge | Cargar



Fully charged | Voll aufgeladen |
complètement chargé | Completamente cargado



Switched on | Eingeschaltet | Allumé | Encendido



Recharge device | Gerät aufladen | Recharger appareil |
Cargar dispositivo



Symbols
Symbolen
Symboles
Símbolos



Battery status – Charging – Low



Remaining time for use | Restnutzungsdauer |
Temps d'utilisation restant | Duración restante de
utilización



Microphone mode: Lanyard/Small Group/Pointing



Network, SubNet



MTN mode = Primary Talker or Equal Talker



Audio – Input/Output/Boom



USB



MTN role = Stand-alone/Primary/Secondary



Screen progress



Quick view



Operation range
Betriebsreichweite
Plage de fonctionnement
Alcance en funcionamiento

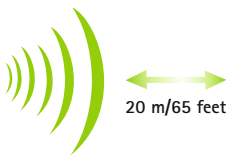

Receivers | Empfänger
Récepteurs | Receptores
Microphones | Mikrofone
Microphones | Micrófonos



Out of range! If distance greater than 20 meters / 65 feet
Ausser Reichweite! Wenn der Abstand größer als 20 Meter ist
Hors de portée! Si distance supérieure à 20 mètres
¡Fuera de alcance! Si la distancia es mayor que 20 metros

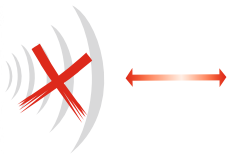

Receivers | Empfänger
Récepteurs | Receptores
Microphones | Mikrofone
Microphones | Micrófonos



Reset
Zurücksetzen
Réinitialiser
Reiniciar





Only Roger transmitters running on software version 4.x are compatible with Roger Touchscreen Mic.

Nur Roger Sender, die über die Software-Version 4.x verfügen, sind mit dem Roger Touchscreen Mic kompatibel.

Seuls les émetteurs Roger ayant la version 4.x ou plus élevée sont compatibles avec Roger Touchscreen Mic.

Sólo emisores Roger que utilizan la versión de software 4.x y la siguientes son compatibles con Roger Touchscreen Mic.

Operating conditions:

Betriebsbedingungen:

0° to +45° Celsius

Conditions de fonctionnement:

32° to +113° Fahrenheit

Condiciones de funcionamiento:

<95%

Relative humidity | relative Luftfeuchtigkeit | humidité relative | humedad relativa



>8 h



Waste Electrical and Electronic Equipment Directive

Elektro- und Elektronikgeräte-Abfall Richtlinie

Directive déchets d'équipements électriques et électroniques

Instrucciones de Residuos de Aparatos Eléctricos y Electrónicos



CE marking

CE-Kennzeichnung

Marquage CE

Marca CE



Class II



Indoor use



Important to read

Wichtig zu lesen

Important de lire

Importante de leer



ACMA - AUS/NZ



Phonak Communications AG
Laenggasse 17
CH-3280 Murten
Switzerland

www.phonak.com/phonak-roger

